



### 标准规格

内径(mm)	32	40	50	63	80	100	125
动作方式	复动型						
工作介质	空气(经40μm滤网过滤)						
固定型式	MBB系列	基本型 FA FB CA CB CR LB TC TCM1 TCM2					
型式	MBBD, MBBJ系列	基本型 FA LB TC TCM1 TCM2					
使用压力范围	0.1~1.0MPa(14~145psi)						
保证耐压力	1.5MPa(215psi)						
工作温度 ℃	-20~80						
使用速度范围 mm/s	30~800						30~500
行程公差范围	0~250 <sup>+1.0</sup> <sub>0</sub>		251~1000 <sup>+1.4</sup> <sub>0</sub>		1001~1500 <sup>+1.8</sup> <sub>0</sub>		
缓冲型式	可调缓冲						
缓冲行程 mm	24			32		37.5 40	
*接管口径	PT1/8	PT1/4		PT3/8		PT1/2	

\*接管牙型有NPT、G牙可供选择。

### 符号

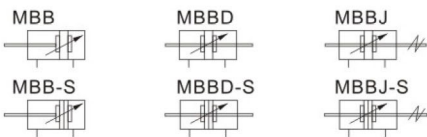

### 产品特性

1. MBB标准气缸
2. 活塞密封采用异型双向密封结构, 尺寸紧凑, 有储油功能;
3. MBB系列为铝管米字型, 无拉杆, 防腐性能好;
4. 与ISO15552标准气缸相比, 同缸径MBB系列气缸长度小;
5. 气缸缓冲调节平稳;
6. 多种规格的气缸及气缸安装附件可供客户选择使用;
7. 选择耐高温密封材料, 可保证气缸在150℃条件下正常工作。

### 行程

内径 (mm)	标准行程															最大行程	容许行程	
32	25	50	75	80	100	125	150	160	175	200	250	300	350	400	450	500	1000	1800
40																1200	1800	
50																1200	1800	
63	25	50	75	80	100	125	150	160	175	200	250	300	350	400	1500	1800		
80	450	500	600	700	800	900	1000	1500	1800									
100																1500	1800	
125																1500	1800	

注: 其它特殊行程请与本公司联系。

### 订购码

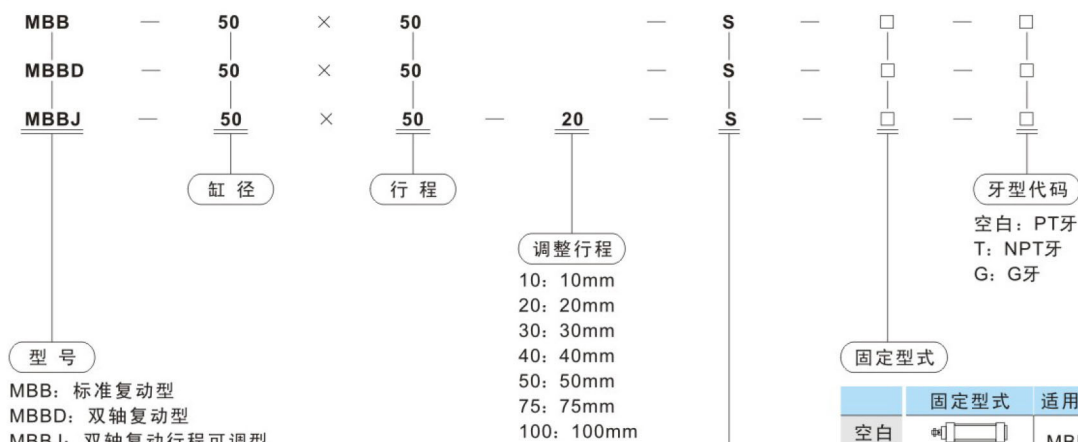

固定型式	适用系列	备注
空白	MBB	
LB	MBBD	
FA	MBBJ	
FB	MBB	
CA		
CB		
CR		与CB配合使用
TC	MBB MBBD MBBJ	与TCM1 TCM2 配合使用

外形尺寸图(毫米)

● MBB

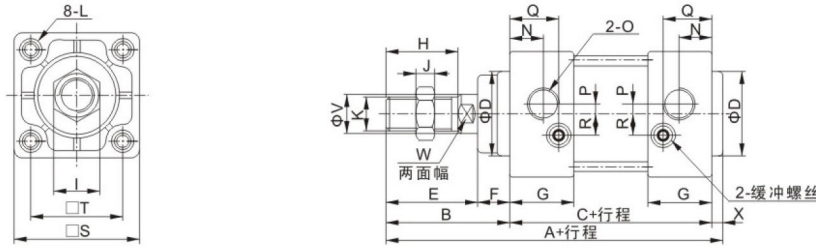

注：附磁型与不附磁型之尺寸相同。

缸径/符号	A	B	C	D	E	F	G	H	I	J	K	L	N	O	P	Q	R	S	T	V	W	X
32	135	47	84	30	34	13	27	22	17	6	M10×1.25	M6	13	PT1/8	4	20.5	6.5	46	32.5	12	10	4
40	139	51	84	35	38	13	27	30	19	8	M14×1.5	M6	14	PT1/4	4	20.5	9	52	38	16	14	4
50	156	58	94	40	44	14	31.5	35	27	11	M18×1.5	M8	15.5	PT1/4	5	23	10.5	65	46.5	20	18	4
63	156	58	94	45	44	14	30.5	35	27	11	M18×1.5	M8	16.5	PT3/8	9	23	12	75	56.5	20	18	4
80	190	72	114	45	52	20	38	40	32	13	M22×1.5	M10	19	PT3/8	11.5	26.5	14	95	72	25	22	4
100	190	72	114	55	52	20	38	40	36	13	M26×1.5	M10	19	PT1/2	17	28.5	15	114	89	30	26	4
125	223	97	120	60	70	27	38	54	41	13.5	M27×2	M12	19	PT1/2	17	29	15	137	110	32	27	6

● MBBD

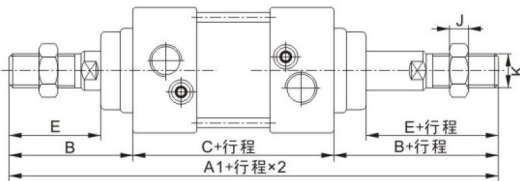

缸径/符号	A1	A2	B	C	E	J	J1	Z	K	K1
32	178	171	47	84	34	6	6	27	M10×1.25	M10×1.25
40	186	176	51	84	38	8	7	28	M14×1.5	M12×1.25
50	210	195	58	94	44	11	8	29	M18×1.5	M16×1.5
63	210	195	58	94	44	11	8	29	M18×1.5	M16×1.5
80	258	241.5	72	114	52	13	10	35.5	M22×1.5	M20×1.5
100	258	248.5	72	114	52	13	13.5	42.5	M26×1.5	M27×2
125	314	286.5	97	120	70	13.5	13.5	42.5	M27×2	M27×2

● MBBJ

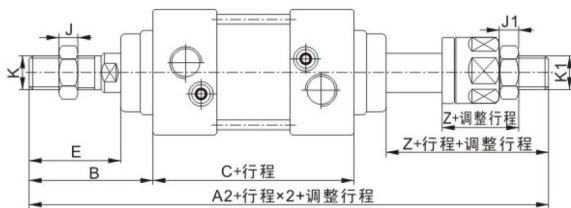

注：1. 附磁型与不附磁型之尺寸相同。  
2. 未标注之尺寸与MBB标准型相同。

● CA

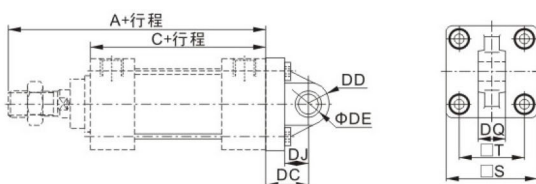

符号/缸径	32	40	50	63	80	100	125
A	131	135	152	152	186	186	217
C	84	84	94	94	114	114	120
S	46	52	65	75	95	114	136
T	32.5	38	46.5	56.5	72	89	110
DC	23	23	30	30	42	42	50
DD	10.5	11	15	15	23	23	28
DE	10	10	14	14	22	22	25
DJ	13	13	17	17	27	27	28
DQ	13.8	13.8	19.8	19.8	29.8	29.8	31.8

●CB

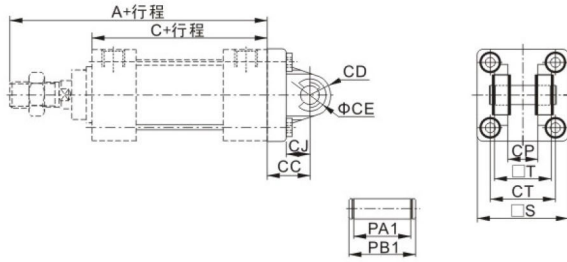

符号/缸径	32	40	50	63	80	100	125
A	131	135	152	152	186	186	217
C	84	84	94	94	114	114	120
CC	23	23	30	30	42	42	50
CD	10.5	11	15	15	23	23	28
CE	10	10	14	14	22	22	25
CJ	14	14	18	18	27	27	32
CP	14.2	14.2	20.2	20.2	30.2	30.2	32.2
CT	32.5	38	46.5	56.5	72	89	110
PA1	28.8	28.8	40.8	40.8	60.8	60.8	64.8
PB1	34.6	34.6	47	47	69.2	69.2	73.2
S	46	52	65	75	95	114	136
T	28	28	40	40	60	60	64

●TC

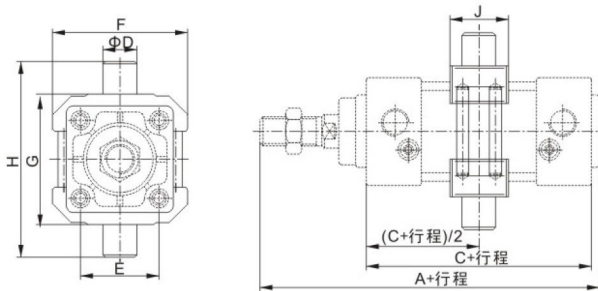

符号/缸径	32	40	50	63	80	100	125
A	135	139	156	156	190	190	223
C	84	84	94	94	114	114	120
D	12	16	16	20	20	25	25
E	32.5	38	46.5	56.5	72	89	110
F	52	65	75	90	112	135	170
G	50	63	75	90	110	132	160
H	74	95	107	130	150	182	210
J	22	28	28	30	32	38	40

注：附件安装位置不可任意调整。

●FA

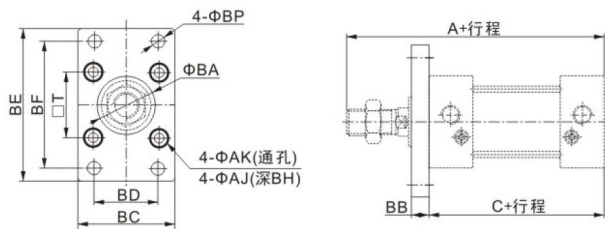

符号/缸径	32	40	50	63	80	100	125
A	131	135	152	152	186	186	217
C	84	84	94	94	114	114	120
AJ	11	11	14	14	17	17	19
AK	6.5	6.5	9	9	11	11	13
BA	30.5	35.5	40.5	45.5	45.5	55.5	60.5
BB	10	10	12	12	16	16	20
BC	47	53	65	75	95	115	138
BD	32	36	45	50	63	75	102
BE	80	90	108	118	150	176	216
BF	64	72	90	100	126	150	180
BH	6.5	6.5	8.5	8.5	10.5	10.5	12.5
BP	7	9	9	9	12.5	14.5	14
T	32.5	38	46.5	56.5	72	89	110

●FB

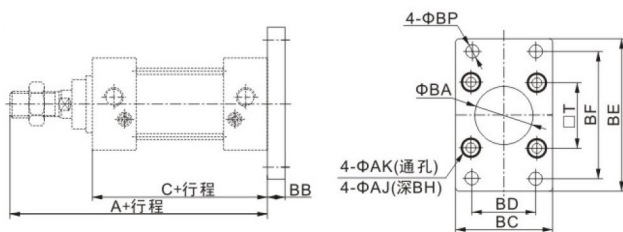

●LB

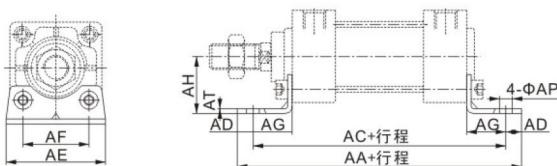

符号/缸径	32	40	50	63	80	100	125
AA	146	154	170	176	202	210	250
AC	128	132	148	148	174	178	210
AD	9	11	11	14	14	16	20
AE	50	55	70	80	100	120	136
AF	32	38	46	56	72	89	90
AG	22	24	27	27	30	32	45
AH	30	33	40	45	55	65	81
AP	7	9	9	12	12	14	14
AT	3	3	3	4	5	5	8

● CR

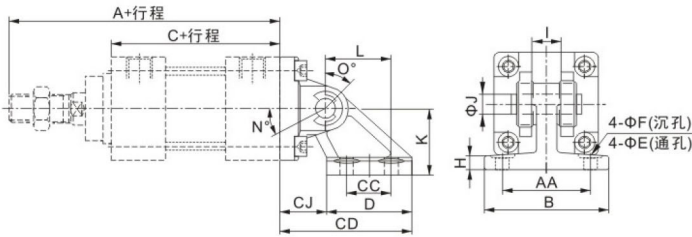

符号/缸径	32	40	50	63	80	100	125
A	131	135	152	152	186	186	217
AA	44	44	60	60	86	86	110
B	62	62	81	81	111	111	136
C	84	84	94	94	114	114	120
CC	22	22	30	30	45	45	60
CD	65	65	84.5	84.5	120	120	143
CJ	23	23	31.5	31.5	47	47	53
D	42	42	53	53	73	73	90
E	6.6	6.6	9	9	11	11	13.5
F	12	12	15	15	18	18	20
H	7	7	8	8	10	10	14
I	13.8	13.8	19.8	19.8	29.8	29.8	31.8
J	10	10	14	14	22	22	25
K	33	33	45	45	65	65	75
L	32	32	43	43	64	64	78
N	25	25	40	40	30	30	30
O	45	45	60	60	55	55	50
N+O+90°	160	160	190	190	175	175	170

● TCM1

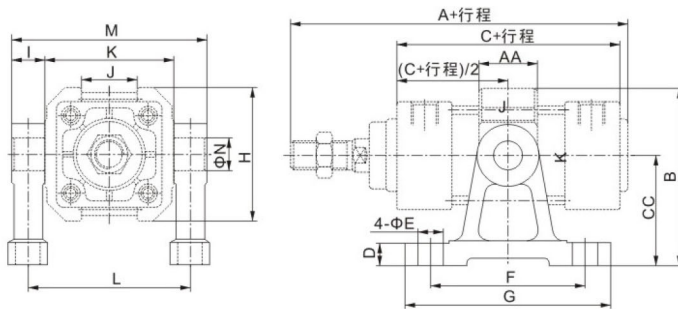

注：附件安装位置不可任意调整。

符号/缸径	32	40	50	63	80	100	125
A	135	139	156	156	190	190	223
AA	22	28	28	30	32	38	40
B	66	86.5	91.5	115	126	157.5	175
C	84	84	94	94	114	114	120
CC	40	54	54	70	70	90	90
D	11	11	11	11	11	19	19
E	9	12	12	12	12	18	18
F	60	75	75	85	85	115	115
G	80	100	100	110	110	155	155
H	52	65	75	90	112	135	170
I	12	16	16	20	20	25	25
J	20	27	31	42	54	68	80
K	50	63	75	90	110	132	160
L	62	79	91	110	130	157	185
M	77	98	110	133	153	185	213
N	12	16	16	20	20	25	25

● TCM2

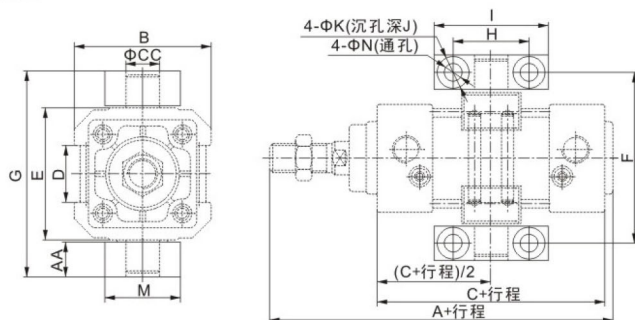

注：附件安装位置不可任意调整。

符号/缸径	32	40	50	63	80	100	125
A	135	139	156	156	190	190	223
AA	14	17	17	20.5	20.5	24.5	24.5
B	52	65	75	90	112	135	170
C	84	84	94	94	114	114	120
CC	12	16	16	20	20	25	25
D	20	27	31	42	54	68	80
E	50	63	75	90	110	132	160
F	66	82	94	113.5	133.5	159.5	187.5
G	80	99	111	134	154	184	212
H	32	36	36	42	42	50	50
I	46	55	55	65	65	75	75
J	6.8	9	9	11	11	14	14
K	11	15	15	18	18	20	20
M	30	36	36	40	40	50	50
N	7	9	9	11	11	14	14

气缸理论出力表

$$F=P \frac{d^2 \cdot \pi \cdot 10}{4}$$

F=理论气缸出力(N)

p=空气压力(bar)

d=活塞杆直径(mm)

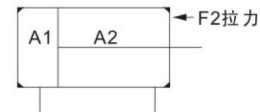
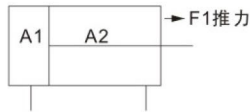

气缸内径	活塞杆直径 (mm)	出力F (mm)	受压面积 (cm <sup>2</sup> )	工作压力(Mpa)						
				0.2	0.3	0.4	0.5	0.6	0.7	0.8
6	3	F1	0.28	5.6	8.4	11.2	14	16.8	19.6	22.4
		F2	0.21	4.2	6.3	8.4	10.5	12.6	14.7	16.8
10	4	F1	0.79	15.8	23.7	31.6	39.5	47.4	55.3	63.2
		F2	0.66	13.2	19.8	26.4	33	39.6	46.2	52.8
12	6	F1	1.13	22.6	33.9	43.2	56.5	67.8	79.1	90.4
		F2	0.85	17.0	25.5	34.0	42.5	51.0	59.5	68.0
16	6	F1	2.01	40.2	60.3	80.4	100.5	120.6	140.7	160.8
		F2	1.72	34.4	51.6	68.8	86	103.2	120.4	137.6
20	8	F1	3.14	62.8	94.2	125.7	157.1	188.5	220.0	251.0
		F2	2.64	52.8	79.2	105.6	132.0	158.4	184.8	211.2
25	10	F1	4.91	98.2	147.3	196.3	245.0	294.0	344.0	393.0
		F2	4.12	82.4	123.4	164.8	206.0	247.2	288.4	329.6
32	12	F1	8.03	160.6	240.9	321.2	401.5	481.8	562.1	642.4
		F2	6.91	138.2	207.3	276.4	345.5	414.6	483.7	552.8
40	14	F1	12.57	251.0	377.0	503.0	628.0	754.0	880.0	1010.0
		F2	11.03	220.3	330.9	441.2	551.5	661.8	772.1	882.4
40	16	F1	12.57	251.0	377.0	503.0	628.0	754.0	880.0	1010.0
		F2	10.56	211.0	317.0	422.0	528.0	633.0	799.0	844.0
50	20	F1	19.63	393	589	785	982	1178	1374	1571
		F2	16.94	330	495	660	825	990	1155	1319
63	20	F1	31.2	623	935	1247	1559	1870	2180	2490
		F2	28.0	561	841	1121	1402	1682	1962	2240
80	25	F1	50.3	1005	1508	2010	2510	3020	3520	4020
		F2	45.4	907	1361	1814	2270	2720	3170	3630
100	25	F1	78.5	1571	2360	3140	3930	4710	5500	6280
		F2	71.5	1429	2140	2860	3570	4290	5000	5720
125	32	F1	122.7	2450	3680	4910	6135	7360	8590	9820
		F2	114.6	2290	3440	4580	5730	6880	8020	9170
160	40	F1	201.0	4020	6030	8040	10050	12060	14070	16080
		F2	188.4	3760	5650	7530	9400	11300	13180	15070
200	50	F1	314.2	6280	9420	12560	15710	18850	21990	25130
		F2	301.4	6020	9040	12050	15070	18080	21090	24110
250	50	F1	490.6	9812	14718	19624	24530	29436	34342	39248
		F2	471	9420	14130	18840	23550	28260	32970	37680
320	70	F1	803.84	16077	24115	32154	40192	48230	56269	64307
		F2	772.68	15454	23180	30907	38634	46361	54088	61814
400	80	F1	1256	25120	37680	50240	62800	75360	87920	100480
		F2	1205.76	24115	36172	48230	60288	72345	84403	96460

注：F1=气缸推力 F2=气缸拉力